

# SHARP

Be Original.

## 8M-B120C

Professional LCD Monitor

All-enveloping realism  
8K quality takes you to another world



### 8K

7680 × 4320 Pixels

# Lifelike 8K for brighter, livelier big-screen images



## 120-inch 8K LCD—one of the world's largest\*

To deliver unparalleled detail, 8K packs in 33 million pixels—four times what you get on a 4K panel. The combination of 8K ultra-high resolution and a mammoth 120-inch panel creates an incredibly immersive effect—putting you right inside the scene.

\*For an 8K LCD monitor, as of July 29, 2020; based on Sharp research.

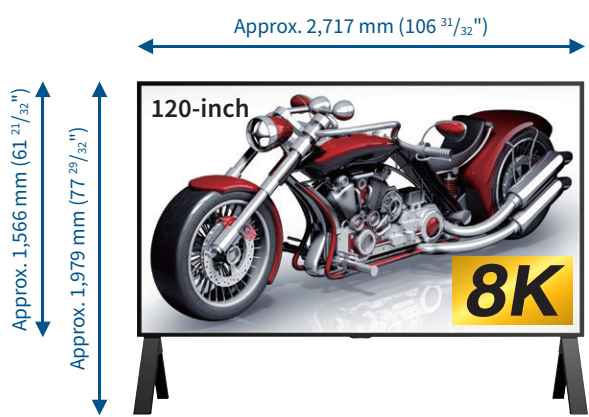

## 4K and full-HD upscaled to 8K

Sharp's super-resolution technology analyses video signals to work out the details that are inherent in the original subject and reconstructs minute details. This enables 4K and full-HD content to be upscaled to 8K. You get clear, ultra-high-resolution images.



## One billion colours for exceptional vividness

The 8K display employs a wide-colour-gamut colour filter and optimised LED backlight phosphors. This allows the display to reproduce a rich colour gamut (ITU-R BT.2020). You'll see improved reproduction of reds—a tell-tale measure of vividness—and improved gradations of red, blue, and green in the pixels. The rich colour palette of an 8K monitor adds depth to content and brings the entire screen to life.

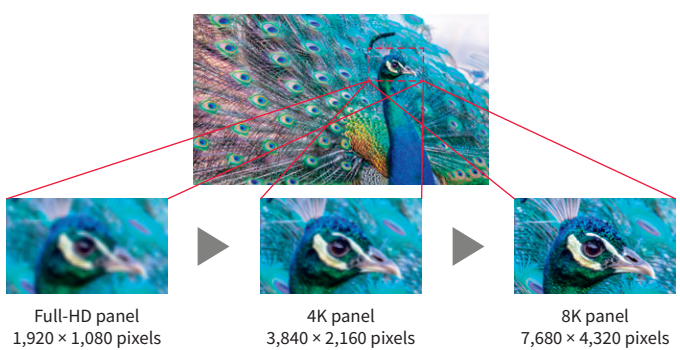

Note: Photos pictorially illustrate differences in resolution.

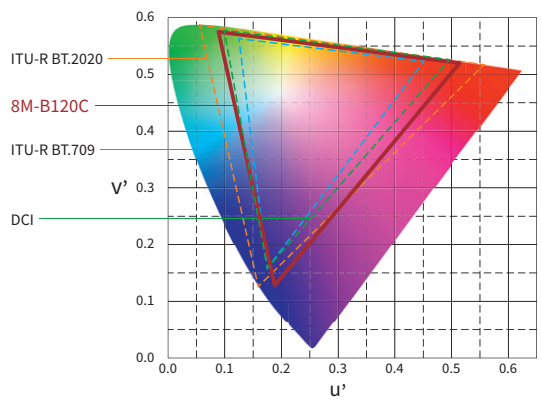



Note: 16-hour continuous operation

### Area-divided full-array LED backlight

The backlight's LEDs sit behind the LCD panel in 2,048 uniform areas. The brightness of the LEDs is controlled independently for each of these areas. Light and dark areas are more distinct, and contrast is improved to deliver lifelike images.

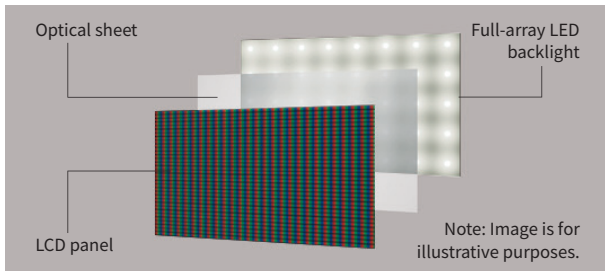

### HDR\* for truly realistic depth and texture

The LCD monitor's image-processing engine restores the wide luminance data recorded in the HDR (High Dynamic Range) standard. Images are then optimally displayed on the high-contrast, low-reflection LCD panel, reproduced with a realistic sense of depth and texture.

\*A technology to expand the luminance data contained in the image to make it even more realistic.

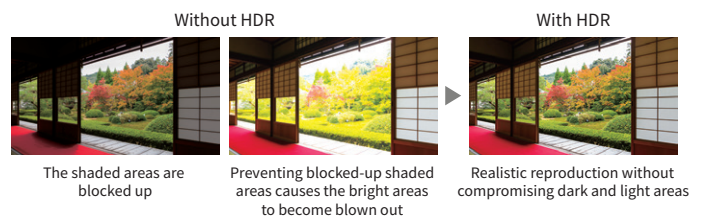

### Multi-screen and other display modes

Content in resolutions up to 4K can be enlarged and upscaled to 8K by the LCD monitor. It can also connect to four PCs via video cables to show content from the PCs on one large screen (a 2 × 2 split screen). You can also choose where to show each image on the screen or display them in a size of your choice.



Mode 1 displays enlarged content in up to 4K resolution (upscaled to 8K)



Mode 2 shows four 4K images to display in 8K resolution



Mode 3 displays four different images (multi-screen)

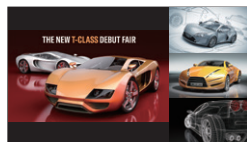

Mode 4 displays four different images in varying sizes (flexible multi-screen)

### Easy connection via a single HDMI™ cable\*

The LCD monitor supports 8K60p/4K120p input via a single HDMI cable.

\*Supports 7,680 × 4,320p 60 Hz and 3,840 × 2,160p 120 Hz, as per the HDMI 2.1 specifications.

### Command control via PC

The LCD monitor has a LAN port that lets you control the monitor from a remote PC. You can turn the power on and off, change inputs, and more.

### Flexible installation

The LCD monitor comes bundled with a floor stand and wall-mounting brackets—no need for extra hardware\*. Eyebolts are provided on the LCD monitor, so you can move the monitor using a crane or other lifting device.

\*Certain installation locations may require additional hardware. Installation costs are not included in the product price. For conditions applying to installation, please consult with your local authorised Sharp dealer or representative before purchase. Also be sure to check for safety (such as wall strength) before installing.

## Specifications

Model Name		8M-B120C
Installation		Landscape
LCD Panel		120-inch class (120-inch [304.8 cm] diagonal) UV <sup>*1</sup> LCD
Backlight		Full-array LED
Max. Resolution		7,680 × 4,320 pixels
Max. Display Colours (approx.)		1.07 billion colours
Pixel Pitch (H × V)		0.346 × 0.346 mm
Brightness <sup>*2</sup>		600 cd/m <sup>2</sup>
Contrast Ratio		3,500:1
Viewing Angle (H/V)		176°/176° (CR ≥ 10)
Active Screen Area (W × H)		2,657.2 × 1,494.7 mm (104 <sup>5</sup> / <sub>8</sub> " × 58 <sup>27</sup> / <sub>32</sub> "
Response Time		6 ms (grey to grey, avg.)
Video		Analogue RGB (0.7 Vp-p) [75Ω], HDMI compliant
Synchronisation		Horizontal/vertical separation (TTL: positive/negative)
Plug & Play		VESA DDC2B
Input Terminals <sup>*3</sup>		HDMI: (INPUT 1: HDR [PQ/HLG] compatible, INPUT 2: ARC compatible) × 4 HDMI (for 8K): (INPUT 7: HDR [PQ/HLG] compatible, HDMI × 4) × 1 HDMI (for 8K): (INPUT 8: HDR [PQ/HLG] compatible, HDMI × 1) × 1 <sup>*4</sup> PC analogue: Mini D-sub 15-pin × 1; USB (photos, video, music) × 2; 3.5 mm-diameter mini stereo jack (video/analogue audio) × 1 <sup>*5</sup>
Output Terminals <sup>*3</sup>		Digital audio (optical) × 1; 3.5 mm-diameter mini stereo jack (analogue audio) × 1; headphones × 1
Input/Output Terminals <sup>*3</sup>		LAN port (10Base-T/100Base-TX) × 1
Speaker Output		70 W (10 W + 10 W + 10 W + 10 W + 15 W + 15 W)
Mounting		8 points; pitch: 800 × 800 mm, 800 × 400 mm; M8 screw
Power Supply		200 V to 240 V, 50/60 Hz
Continuous Operation		16 hours
Power Consumption		1,520 W (standby 0.5 W)
Operating Temperature <sup>*6</sup>		0°C to 40°C
Operating Humidity		20% to 80% RH (no condensation)
Dimensions (W × D × H) (approx.) (not including protrusions)		Display Only 2,717 × 173 × 1,566 mm (106 <sup>21</sup> / <sub>32</sub> " × 6 <sup>13</sup> / <sub>16</sub> " × 61 <sup>21</sup> / <sub>32</sub> "
		With Floor Stand 2,717 × 805 × 1,979 mm (106 <sup>21</sup> / <sub>32</sub> " × 31 <sup>11</sup> / <sub>16</sub> " × 77 <sup>29</sup> / <sub>32</sub> "
Weight (approx.) (not including protrusions)		Display Only 187 kg (412.3 lbs)
		With Floor Stand 206 kg (454.2 lbs)
Main Accessories		AC power cord (3 meters, 3-pin <sup>*7</sup> ), AV connector conversion cable, remote control unit, battery (AAA size) × 2, set-up manual, cable clamp × 5, floor stand, wall-mounting brackets, eyebolt cover and screws for eyebolt cover (2 sets)

<sup>\*1</sup>: UV<sup>A</sup> stands for Ultraviolet-induced Multi-domain Vertical Alignment, a photo-alignment technology that ensures uniform alignment of liquid crystal molecules. <sup>\*2</sup>: Brightness depends on input mode, power source, and other picture settings (260 cd/m<sup>2</sup> at 100 V). Brightness level will decrease slightly over the lifetime of the product. Due to the physical limitations of the equipment, it is not possible to maintain a precisely constant level of brightness. <sup>\*3</sup>: Use a commercially available connection cable for PC and other video connections. <sup>\*4</sup>: Supports input via one HDMI cable (7,680 × 4,320p 60 Hz and 3,840 × 2,160p 120 Hz, as per the HDMI 2.1 specifications). <sup>\*5</sup>: The terminal is shared with both video and analogue audio. For video input, use the bundled conversion cable. <sup>\*6</sup>: Temperature conditions may change when using the monitor together with optional equipment. In such cases, check the temperature conditions specified by the optional equipment. Also, the operating temperature range may change depending on installation conditions. <sup>\*7</sup>: Use a 3-pin compatible power outlet.

### Compatible Signal Timing (PC)

Screen Resolution	Horizontal Frequency	Vertical Frequency	HDMI				
			INPUT 1	INPUT 2/3/4	INPUT 7	INPUT 8	
4K	3,840 × 2,160	54.0 kHz	24 Hz	●	●	●	●
		56.3 kHz	25 Hz	●	●	●	●
		67.5 kHz	30 Hz	●	●	●	●
		112.5 kHz	50 Hz	●	●	●	●
		135.0 kHz	60 Hz	●	●	●	●
8K	7,680 × 4,320	108.0 kHz	24 Hz	—	—	● <sup>*1*2</sup>	●
		110.0 kHz	25 Hz	—	—	● <sup>*1*2</sup>	●
		132.0 kHz	30 Hz	—	—	● <sup>*1*2</sup>	●
		220.0 kHz	50 Hz	—	—	● <sup>*1*2</sup>	●
		264.0 kHz	60 Hz	—	—	● <sup>*1*2</sup>	●

### Compatible Signal Timing (AV)

Screen Resolution	Frequency	HDMI				
		INPUT 1	INPUT 2/3/4	INPUT 7	INPUT 8	
4K	3,840 × 2,160	24 Hz	●	●	●	●
		25 Hz	●	●	●	●
		29.97 Hz	●	●	●	●
		30 Hz	●	●	●	●
		50 Hz	●	●	●	●
		59.94 Hz	●	●	●	●
		60 Hz	●	●	●	●
8K	7,680 × 4,320	50 Hz	—	—	● <sup>*1*2</sup>	●
		59.94 Hz	—	—	● <sup>*1*2</sup>	●
		60 Hz	—	—	● <sup>*1*2</sup>	●

<sup>\*1</sup>: Uses Mode 2 display mode. <sup>\*2</sup>: Input 7's A to D connectors each support input signals of 3,840 × 2,160 resolution.

## Dimensions

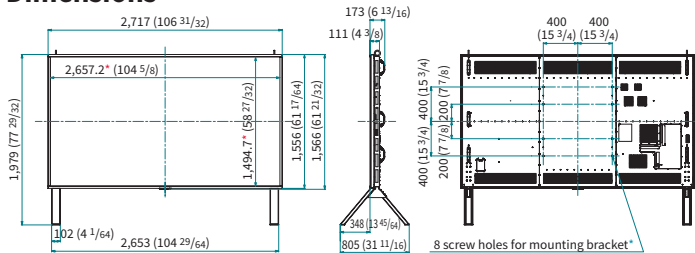

Units: mm (inch)

<sup>\*</sup> Screen dimensions

<sup>\*</sup> To use the mounting bracket, use M8 screws that are 8 to 10 mm plus the thickness of the bracket.

## Input/Output Terminals

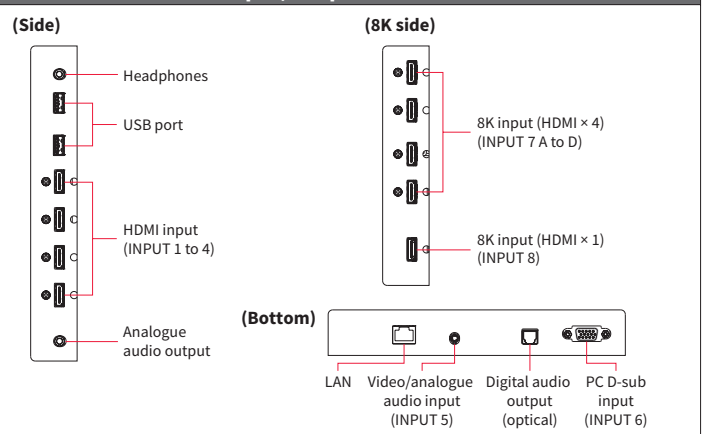

## Main Accessories

### Floor stand



### Wall-mounting brackets



The terms HDMI, HDMI High-Definition Multimedia Interface, and the HDMI Logo are trademarks or registered trademarks of HDMI Licensing Administrator, Inc. Dolby, Dolby Audio, and the double-D symbol are trademarks of Dolby Laboratories. All other brand names and product names may be trademarks or registered trademarks of their respective owners. All screen images appearing in this brochure are simulated. Design and specifications are subject to change without prior notice.

**HDMI**  
HIGH DEFINITION MULTIMEDIA INTERFACE

**DOLBY AUDIO**

Distributed by:

**SHARP**

JXC8MB120C

©SHARP CORPORATION (JUL. 2020)